



ZAVOD ZA  
GRADBENIŠTVO  
SLOVENIJE

SLOVENIAN  
NATIONAL BUILDING  
AND CIVIL ENGINEERING  
INSTITUTE

Član  
Member of



www.eota.eu

**Dimičeva 12,  
1000 Ljubljana, Slovenija**  
Tel.: +386 (0)1 280 44 72, +386 (0)1-280 45 37  
Fax: +386 (0)1 280 44 84  
e-mail: info.ta@zag.si  
http://www.zag.si

## European Technical Assessment

**ETA-13/0416**  
**of 12. 3. 2018**

*English version prepared by ZAG*

### General part

**Organ za tehnično ocenjevanje, ki je izdal ETA** ZAG Ljubljana  
*Technical Assessment Body issuing the ETA*

**Komercialno ime gradbenega proizvoda** AT-HP masonry  
*Trade name of the construction product*

**Družina proizvoda, ki ji gradbeni proizvod pripada** 33: Kovinsko kemično sidro za uporabo v zidakih  
*Product family to which the construction product belongs* 33: Metal injection anchor for use in masonry

**Proizvajalec** SIMPSON STRONG-TIE® - France  
*Manufacturer* ZAC Des Quatre Chemins  
85400 Sainte-Gemme-la-Plaine  
France  
<https://strongtie.eu>

**Proizvodni obrat** SIMPSON STRONG-TIE® Manufacturing  
*Manufacturing plant* Facilities

**Ta Evropska tehnična ocena vsebuje** 17 strani vključno s 14 prilogami, ki so sestavni del te ocene  
*This European Technical Assessment contains* 17 pages including 14 annexes, which form an integral part of the document

**Ta Evropska tehnična ocena je izdana na podlagi Uredbe (EU) št. 305/2011 na podlagi** Smernice za evropska tehnična soglasja ETAG 029, izdaja 2013, ki se uporablja kot EAD  
*This European Technical Assessment is issued in accordance to Regulation (EU) No 305/2011, on the basis of* Guideline for European Technical Approval ETAG 029, edition 2013, used as EAD

Translations of this European Technical Assessment in other languages shall fully correspond to the original issued document and should be identified as such.

Communication of this European Technical Assessment, including transmission by electronic means, shall be in full (excepted the confidential Annex(es) referred to above). However, partial reproduction may be made, with the written consent of the issuing Technical Assessment Body. Any partial reproduction has to be identified as such.

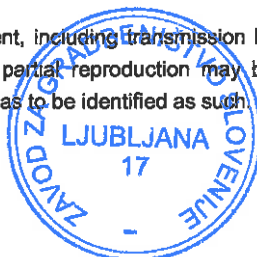

## Specific parts

### 1 Technical description of the product

The injection system AT-HP masonry is a bonded anchor (injection type) consisting of a mortar cartridge with injection mortar AT-HP masonry, a perforated plastic sleeve and an anchor rod (with hexagon nut and washer) of sizes M8, M10 and M12. The steel elements are made of zinc coated steel or stainless steel.

The anchor rod is placed into a drilled hole/perforated plastic sleeve filled with the injection mortar and anchored via the bond and/or mechanical interlock between element, injection mortar and masonry.

An illustration and the description of the product are given in Annex A.

### 2 Specification of the intended use

The performances given in Chapter 3 are only valid if the anchor is used in compliance with the specifications and conditions given in Annex B.

The provisions made in this European Technical Assessment are based on an assumed working life of the anchor of at least 50 years. The indications given on the working life cannot be interpreted as a guarantee given by the manufacturer, but are to be regarded only as a means for choosing the right products in relation to the expected economically reasonable working life of the works.

### 3 Performance of the product and references to the methods used for this assessment

#### 3.1 Mechanical resistance and stability (BWR 1)

The essential characteristics for mechanical resistance and stability are listed in Annexes C1 to C3.

#### 3.2 Safety in case of fire (BWR 2)

Anchorage satisfies requirements for Class A1 relating to Reaction to fire.

Resistance to fire isn't relevant.

#### 3.3 Hygiene, health and environment (BWR 3)

Regarding dangerous substances contained in this European Technical Assessment, there may be requirements applicable to the products falling within its scope (e.g. transported European legislation and national laws, regulations and administrative provisions). In order to meet provisions of the regulation (EU) No 305/2011, these requirements need also to be complied with, when they apply.

#### 3.4 Safety in use (BWR 4)

For basic requirement safety in use the same criteria are valid as for basic requirement mechanical resistance and stability.

#### 3.5 Protection against noise (BWR 5)

Not relevant.

#### 3.6 Energy economy and heat retention (BWR 6)

Not relevant.

#### 3.7 Sustainable use of natural resources (BWR 7)

For sustainable use of natural resources no performance was assessed for this product.

#### 3.8 General aspects relating to fitness for use

Durability and serviceability are only ensured if specifications of intended use according to Annex B1 are kept.



**4 Assessment and verification of constancy of performance (AVCP)**

According to the decision 97/177/EC of the European Commission<sup>1</sup> the system of assessment and verification of constancy of performance (AVCP) 1 apply.

**5 Technical details necessary for the implementation of the AVCP system**

Technical details necessary for the implementation of AVCP system are laid down in the Control plan deposited at ZAG Ljubljana.

Issued in Ljubljana on 12. 3. 2018

Signed by:

Franc Capuder, M.Sc.

Head of Service of TAB



**Anchor rods**

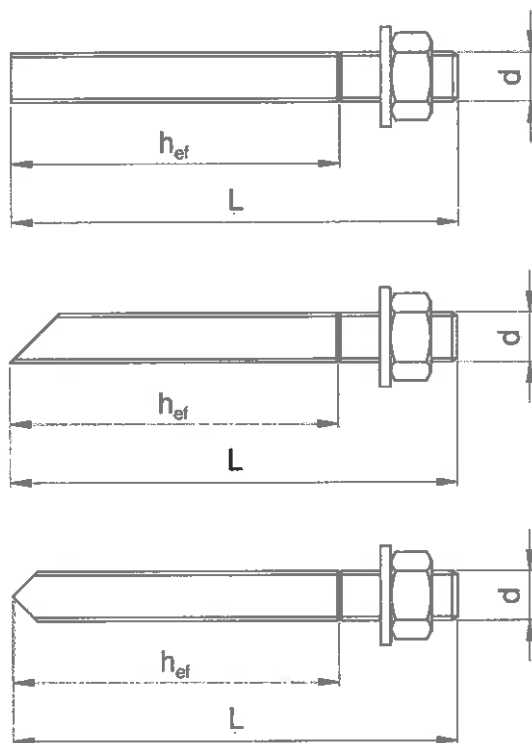

**Perforated plastic sleeve**



Diameter of the sleeve:  $d_s = 16 \text{ mm}$   
 Length of the sleeve:  $l_s = 85 \text{ mm}, 130 \text{ mm}$

<p><b>AT-HP masonry</b></p>	<p><b>Annex A1</b></p>
<p><b>Product description</b>                  Components of the anchor</p>	



**Installation in solid masonry**

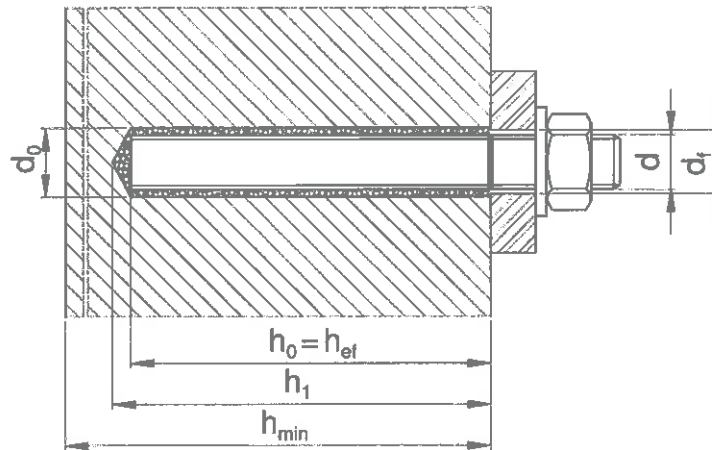



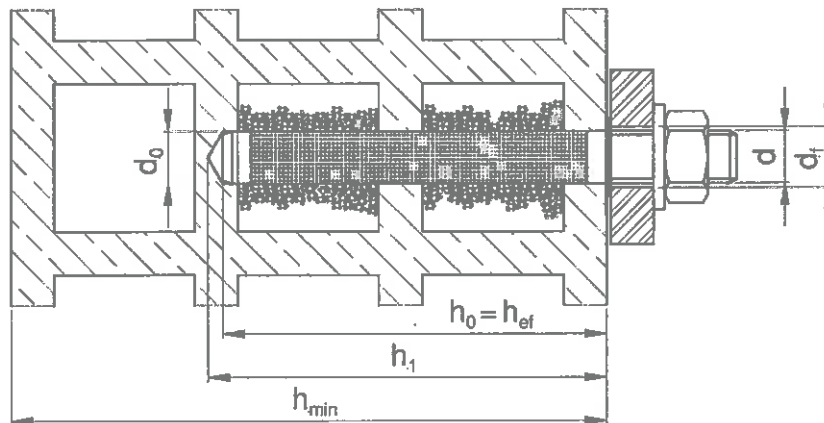









**Installation in hollow or perforated masonry**

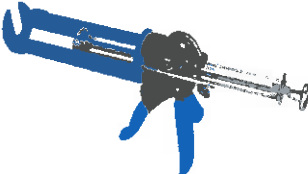

- d = diameter of the threaded rod
- $d_0$  = diameter of drill bit
- d = diameter of the threaded rod
- $d_f$  = diameter of clearance hole in the fixture
- $h_{ef}$  = effective anchorage depth
- $h_{min}$  = minimum thickness of the base material
- $h_1$  = depth of drilled hole to deepest point

<b>AT-HP masonry</b>	<b>Annex A2</b>
<b>Product description</b> Installed condition	



<b>Mortar cartridges and applicator guns</b>			
	<b>Cartridge</b>	<b>Applicator gun</b>	<b>Mixing nozzle</b>
Coaxial cartridge: 160 ml/ 280 ml		 DT 300	 MN1
Sausage cartridge: 170ml / 300 ml			
Side by side cartridge: 345 ml		 DT 345	 MN20
Coaxial cartridge: 380 ml		 DT 380	
Side by side cartridge: 825 ml		 DT 825	 MN3
<b>AT-HP masonry</b>		<b>Annex A3</b>	
<b>Product description</b> Injection system			



**Table A1: Materials**

Part		Material
1	Chemical mortar AT-HP masonry	Methacrylate, blue/grey <sup>1)</sup>
2	Perforated plastic sleeve	Polypropylene
3	Threaded rod	<p><b>Zinc electroplated steel <math>\geq 5 \mu\text{m}</math> according to EN ISO 4042 (A2)</b>  <b>Hot-dip galvanized steel <math>\geq 40 \mu\text{m}</math> according to EN ISO 10684</b>  Carbon steel property class 5.8 or 8.8 acc. to EN ISO 898-1  <b>Stainless steel</b>  Stainless steel: 1.4362, 1.4401, 1.4404, 1.4439, 1.4571, 1.4578 according to EN 10088,  property class 70 according to EN ISO 3506-1  <b>Stainless steel – High corrosion resistance steel (HCR)</b>  Stainless steel: 1.4529, 1.4565 according to EN 10088,  property class 70 according to EN ISO 3506-1  <b>Commercial threaded rods</b>  with Inspection certificate 3.1 according to EN 10204:2004 and marking of embedment depth (this may be done by the manufacturer of the rod or by the worker in jobsite)</p>
4	Hexagon nut	<p><b>Zinc electroplated steel <math>\geq 5 \mu\text{m}</math> according to EN ISO 4042 (A2)</b>  <b>Hot-dip galvanized steel <math>\geq 40 \mu\text{m}</math> according to EN ISO 10684</b>  According to DIN 934 (EN ISO 4032), property class 8 according to EN ISO 898-2  <b>Stainless steel</b>  According to DIN 934 (EN ISO 4032), property class 70 according to EN ISO 3506-2,  Stainless steel: 1.4362, 1.4401, 1.4404, 1.4439, 1.4571, 1.4578 according to EN 10088  <b>Stainless steel – High corrosion resistance steel (HCR)</b>  According to DIN 934 (EN ISO 4032), property class 70 according to EN ISO 3506-2,  Stainless steel: 1.4529, 1.4565 according to EN 10088</p>
5	Washer	<p><b>Zinc electroplated steel <math>\geq 5 \mu\text{m}</math> according to EN ISO 4042 (A2)</b>  <b>Hot-dip galvanized steel <math>\geq 40 \mu\text{m}</math> according to EN ISO 10684</b>  According to DIN 125 (EN ISO 7089), DIN 440 (EN ISO 7094), DIN 9021 (EN ISO 7093)  <b>Stainless steel</b>  According to DIN 125 (EN ISO 7089), DIN 440 (EN ISO 7094), DIN 9021 (EN ISO 7093)  Stainless steel: 1.4362, 1.4401, 1.4404, 1.4439, 1.4571, 1.4578 according to EN 10088  <b>Stainless steel – High corrosion resistance steel (HCR)</b>  According to DIN 125 (EN ISO 7089), DIN 440 (EN ISO 7094), DIN 9021 (EN ISO 7093),  Stainless steel: 1.4529, 1.4565 according to EN 10088</p>

<sup>1)</sup> Change of the colour happened after curing above 5°C

**AT-HP masonry**

**Product description**  
**Materials**

**Annex A4**



**Specifications of intended use****Anchorage subjected to:**

- Static, quasi static load.

**Base materials:**

- Solid brick masonry (use category b), according to Annex B3.
- Hollow or perforated brick masonry (use category c), according to Annex B3.
- Autoclaved aerated concrete masonry (use category d), according to Annex B3.
- Mortar strength class of masonry M 2,5 at minimum according to EN 998-2:2016.
- For masonry made of other solid, hollow or perforated bricks, the characteristic resistance of the anchor may be determined by job site tests according to ETAG 029, Annex B under consideration of the  $\beta$ -factor according to Annex C2, Table C4.

**Use conditions (Environmental conditions):**

- Structures subject to dry internal conditions (zinc coated steel, stainless steel high corrosion resistant steel)
- Structures subject to external atmospheric exposure (including industrial and marine environment) and exposure in permanently damp internal conditions, if no particular aggressive conditions exist (stainless steel or high corrosion resistant steel).
- Structures subject to external atmospheric exposure and to permanently damp internal conditions, if other particular aggressive conditions exists (high corrosion resistant steel).

Note: Particular aggressive conditions are e.g. permanent, alternating immersion of seawater or the splash zone of seawater, chloride atmosphere of indoor swimming pools or atmosphere with extreme chemical pollution (e.g. desulphurization plants or road tunnels where de-icing material are used).

**Temperature range:**

- Service temperature range from  $-40^{\circ}\text{C}$  to  $+80^{\circ}\text{C}$  (maximum long term temperature  $+50^{\circ}\text{C}$  and maximum short term temperature  $+80^{\circ}\text{C}$ ).

**Design:**

- Verifiable calculation notes and drawings are prepared taking account the relevant masonry in the region of the anchorage (nature and strength of the base materials), the loads to be transmitted and their transmission to the supports of the structure. The position of the anchor is indicated on the design drawings (e.g. position of the anchor relative to the supports etc.).
- The anchorages are designed in accordance with the ETAG 029 – Annex C "Metal injection anchors for use in masonry – design methods for anchorages", Design Method A under the responsibility of an engineer experienced in anchorages and masonry work.

<b>AT-HP masonry</b>	
<b>Intended use Specifications</b>	<b>Annex B1</b>





**Specifications of intended use - continuing****Installation:**

- Anchor installation carried out by appropriately qualified personnel under the supervision of the person responsible for technical matters on site.
- Use of the anchor only as supplied by the manufacturer without exchanging any component of the anchor.
- Anchor installation in accordance with the manufacturer's specifications and drawings using tools indicated in this European Technical Assessment.
- Commercial standard threaded rods, washers and hexagon nuts may also be used if the following requirements are fulfilled:
  - Material, dimensions and mechanical properties of the metal parts according to the specification given in Annex A4, Table A1 and Annexes B4 – B5, Tables B2 – B7,
  - Confirmation of material and mechanical properties of the metal parts by inspection certificate 3.1 according to EN 10204:2004, the documents should be stored,
  - Marking of the threaded rod with the envisage embedment depth. This may be done by the manufacturer of the rod or the person on jobsite.
- Checks before placing the anchor, to ensure that the characteristic values of the base material in which the anchor is to be placed, is identical with the values, which the characteristic loads apply for.
- Holes to be drilled perpendicular to the surface of the base material.
- In case of aborted hole the drill hole should be filled with mortar.
- Hole cleaning and anchor installation in accordance with the manufacturer's installation instructions (Annexes B6 and B7).
- Keeping the installation parameters (Annexes B4 and B5).
- Marking and keeping the effective anchorage depth.
- Keeping edge distance and spacing according to Annex C3 without minus tolerances.
- Observation of the curing time according to Annex B5, Table B8 until the anchor may be loaded.

**AT-HP masonry****Intended use  
Specifications****Annex B2**

**Table B1: Types of solid and hollow/perforated masonry**

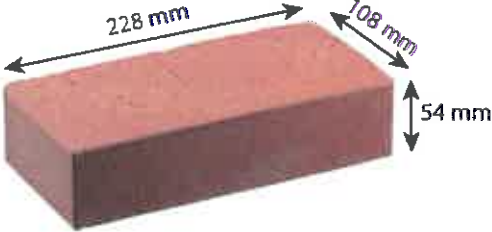
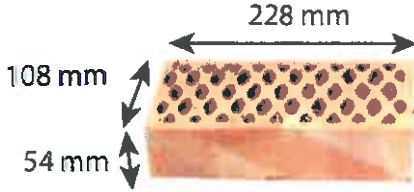
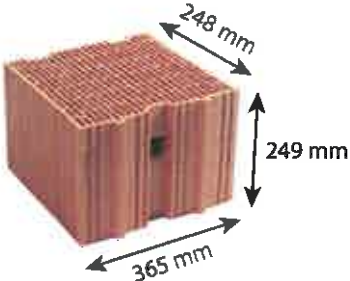
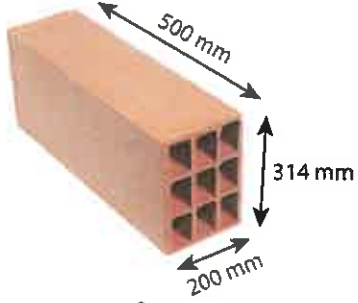
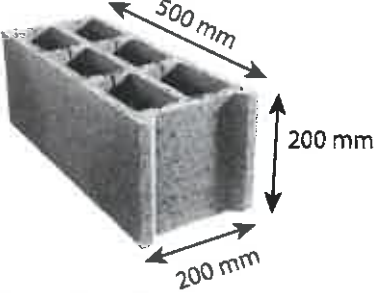
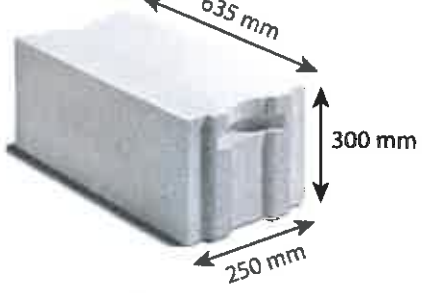
<p>Solid clay brick RT 307 according to EN 771-1 – HD</p>  <p><math>f_b \geq 22 \text{ N/mm}^2</math> <math>\rho \geq 1830 \text{ kg/m}^3</math></p>	<p>Hollow clay brick RT 301– Type 1 according to EN 771-1 – LD</p>  <p><math>f_b \geq 22 \text{ N/mm}^2</math> <math>\rho \geq 1305 \text{ kg/m}^3</math></p>
<p>Hollow clay brick POROTON– Type 2 according to EN 771-1 – LD</p>  <p><math>f_b \geq 8 \text{ N/mm}^2</math> <math>\rho \geq 650 \text{ kg/m}^3</math></p>	<p>Hollow clay brick LS BGV THERMO – Type 3 according to EN 771-1 – LD</p>  <p><math>f_b \geq 6 \text{ N/mm}^2</math> <math>\rho \geq 570 \text{ kg/m}^3</math></p>
<p>Concrete hollow block – Type 4 according to EN 771-3 – LD</p>  <p><math>f_b \geq 4 \text{ N/mm}^2</math> <math>\rho \geq 900 \text{ kg/m}^3</math></p>	<p>Autoclaved aerated concrete block according to EN 771 – 4</p>  <p><math>f_b \geq 3 \text{ N/mm}^2</math> <math>\rho \geq 350 \text{ kg/m}^3</math></p>

**AT-HP masonry**

**Intended use**  
Type of bricks and dimensions

**Annex B3**



**Table B2: Installation parameters of anchor rods for solid brick**

		M8	M10	M12
Drill hole diameter	$d_0$ (mm)	10	12	14
Maximum clearance hole in the fixture	$d_f$ (mm)	9	12	14
Effective anchorage depth	$h_{ef}$ (mm)	80		
Depth of the drilling hole	$h_1$ (mm)	85		
Installation torque moment	$T_{inst}$ (nm)	4	6	8

**Table B3: Installation parameters of anchor rods for hollow brick type 1\***

		M8	M10	M12
Drill hole diameter	$d_0$ (mm)	16		
Size of sleeve	$d_s \times l_s$ (mm)	16 x 85		
Maximum clearance hole in the fixture	$d_f$ (mm)	9	12	14
Effective anchorage depth	$h_{ef}$ (mm)	85		
Depth of the drilling hole	$h_1$ (mm)	90		
Installation torque moment	$T_{inst}$ (nm)	4	6	6

**Table B4: Installation parameters of anchor rods for hollow bricks type 2\***

		M8	M10	M12
Drill hole diameter	$d_0$ (mm)	16		
Size of sleeve	$d_s \times l_s$ (mm)	16 x 130		
Maximum clearance hole in the fixture	$d_f$ (mm)	9	12	14
Effective anchorage depth	$h_{ef}$ (mm)	130		
Depth of the drilling hole	$h_1$ (mm)	135		
Installation torque moment	$T_{inst}$ (nm)	4	6	6

**Table B5: Installation parameters of anchor rods for hollow bricks type 3\***

		M8	M10	M12
Drill hole diameter	$d_0$ (mm)	16		
Size of sleeve	$d_s \times l_s$ (mm)	16 x 130		
Maximum clearance hole in the fixture	$d_f$ (mm)	9	12	14
Effective anchorage depth	$h_{ef}$ (mm)	130		
Depth of the drilling hole	$h_1$ (mm)	135		
Installation torque moment	$T_{inst}$ (nm)	4	6	8

\* Type of bricks are detailed in the Annex B3

**AT-HP masonry****Intended use**  
**Installation parameters****Annex B4**

**Table B6: Installation parameters of anchor rods for hollow bricks type 4\***

		M8	M10	M12
Drill hole diameter	$d_0$ (mm)	16		
Size of sleeve	$d_s \times l_s$ (mm)	16 x 130		
Maximum clearance hole in the fixture	$d_f$ (mm)	9	12	14
Effective anchorage depth	$h_{ef}$ (mm)	130		
Depth of the drilling hole	$h_1$ (mm)	135		
Installation torque moment	$T_{inst}$ (nm)	4	4	4

\* Type of bricks are detailed in the Annex B3

**Table B7: Installation parameters of anchor rods for autoclaved aerated concrete**

		M8	M10	M12
Drill hole diameter	$d_0$ (mm)	10	12	14
Maximum clearance hole in the fixture	$d_f$ (mm)	9	12	14
Effective anchorage depth	$h_{ef}$ (mm)	80		
Depth of the drilling hole	$h_1$ (mm)	85		
Installation torque moment	$T_{inst}$ (nm)	4	6	8

**Table B8: Maximum working time and maximum curing time for AT-HP masonry chemical resin**

Temperature of resin	Temperature of support	Working time	Curing time
+5°C	-5°C	45'	9h00'
+5°C	0°C	15'	4h00'
+5°C	+5°C	12'	1h30'
+10°C	+10°C	9'	60'
+20°C	+20°C	4'	30'
+30°C	+30°C	1'	20'

After the minimum curing time the blue injection mortar changes into grey. The curing colour proof works above +5°C.

**AT-HP masonry**

**Intended use**  
Installation parameters

**Annex B5**



### Installation procedure for solid masonry

- 1 Drill hole to the required anchorage depth ( $h_{ef}$ ) with a percussive/hammer drill using specified carbide drill bit diameter ( $d_0$ ).
- 2 The hole shall be cleaned by at least 2 blowing operations, 2 brushing operations followed again by 2 blowing operations starting from the bottom of the hole. The brush shall have a sufficient resistance as it enters the drill hole. If this is not the case a new brush shall be used.
- 3 Remove the cap and install mixing nozzle.  
Using sausage cartridges: Cut to open the sausage.
- 4 Load the cartridge into applicator gun.
- 5 Dispense and discard first part of resin until it is properly mixed (uniform color). 3 strokes at least are needed.
- 6 Fill up the hole approximately 2/3rd with mortar starting at the bottom of the cleaned drilled hole. Withdraw the nozzle slowly step by step after each trigger to avoid creating air pockets.
- 7 Insert a clean, oil free threaded rod, turning slowly until it touches the bottom of the hole or until to the marking of  $h_{ef}$ . Setting control: After the rod has been fully inserted to the marking of embedment depth, excess mortar flows out of the drilled hole. Clean excess resin.
- 8 Do not touch/move the threaded rod until mortar is fully cured. The curing time is given in Table B8. After required curing time the anchor can be loaded. Apply the installation torque  $T_{inst}$  using calibrated torque wrench.



**AT-HP masonry**

**Intended use**  
Installation instructions

**Annex B6**



### Installation procedure for hollow/perforated masonry

- 1 Drill hole to the required depth ( $h_1$ ) with a rotary drill using specified carbide drill bit diameter ( $d_0$ ).



- 2 The hole shall be cleaned by at least 2 brushing operations. The brush shall have a sufficient resistance as it enters the drill hole. If this is not the case a new brush shall be used.



- 3 Insert the sleeve into the hole.



Remove the cap and install mixing nozzle.  
Using sausage cartridges: Cutting to open the sausage.



- 4 Load the cartridge into applicator gun.  
5 Dispense and discard first part of resin until it is properly mixed (uniform color). 3 strokes at least are needed.  
6 Place the mixer at the bottom of the sleeve and inject the mortar as long as the sleeve is completely filled. Withdraw the nozzle slowly step by step after each trigger.

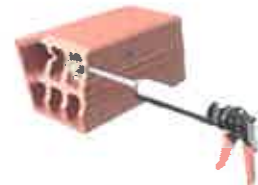

- 7 Insert a clean, oil free threaded rod, turning slowly until it touches the bottom of the sleeve. Clean excess resin.



- 8 Do not touch/move the threaded rod until mortar is fully cured. The curing time is given in Table B8. After required curing time the anchor can be loaded. Apply the installation torque  $T_{inst}$  using calibrated torque wrench.



**AT-HP masonry**

**Intended use**  
Installation instructions

**Annex B7**



**Table C1: Characteristic tension and shear load**

Brick type	Brick parameters: Density $\rho$ (kg/m <sup>3</sup> ) Compressive strength $f_b$ (N/mm <sup>2</sup> )	Sleeve size (mm)	Anchor size	$N_{Rk}$ <sup>1)</sup> (kN)	$V_{Rk}$ <sup>2)</sup> (kN)
Solid clay brick RT 307 according to EN 771-1 HD	$\rho \geq 1830$ $f_b = 22$	/	M8	2	2
			M10	2	2
			M12	2	2
Hollow clay brick RT 301 – Type 1 according to EN 771-1 LD	$\rho \geq 1305$ $f_b = 22$	16 x 85	M8	1,5	1,5
			M10	1,5	1,5
			M12	1,5	1,5
Hollow clay brick POROTON – Type 2 according to EN 771-1 LD	$\rho \geq 650$ $f_b = 8$	16 x 130	M8	1,5	1,5
			M10	1,5	1,5
			M12	2,0	2,0
Hollow clay brick LS BGV THERMO – Type 3 according to EN 771-1 LD	$\rho \geq 570$ $f_b = 6$	16 x 130	M8	1,5	1,5
			M10	2,0	2,0
			M12	3,0	3,0
Hollow concrete block BLOCS CREUX – Type 4 according to EN 771-3 LD	$\rho \geq 900$ $f_b = 4$	16 x 130	M8	1,2	1,2
			M10	2,0	2,0
			M12	2,0	2,0
Autoclaved aerated concrete EN 771-4	$\rho \geq 350$ $f_b = 3$	/	M8	0,9	0,9
			M10	1,2	1,2
			M12	1,2	1,2
Partial safety factor $\gamma_M = 2,5$ <sup>3)</sup>					

<sup>1)</sup> For design according to ETAG 029, Annex C:  $N_{Rk} = N_{Rk,p} = N_{Rk,b} = N_{Rk,pb} = N_{Rk,s}$

<sup>2)</sup> For design according to ETAG 029, Annex C:  $V_{Rk} = V_{Rk,b} = V_{Rk,c} = V_{Rk,s}$

<sup>3)</sup> In absence of other national regulations

**AT-HP masonry**

**Performances**  
Characteristic tension and shear load

**Annex C1**

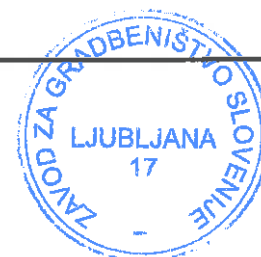

**Table C2: Characteristic bending moments**

Size			M8	M10	M12
Characteristic bending moment for threaded steel rod grade 5.8	$M_{Rk,s}$	(Nm)	20	39	68
Partial safety factor	$\gamma_{Ms}$	(-)	1,25		
Characteristic bending moment for threaded steel rod grade 8.8	$M_{Rk,s}$	(Nm)	30	60	105
Partial safety factor	$\gamma_{Ms}$	(-)	1,25		
Characteristic bending moment for threaded stainless rod A4-70	$M_{Rk,s}$	(Nm)	26	52	92
Partial safety factor	$\gamma_{Ms}$	(-)	1,56		

**Table C3: Displacement under tension and shear load**

	F (kN)	$\delta_{N0}$ (mm)	$\delta_{N\infty}$ (mm)	$\delta_{V0}$ (mm)	$\delta_{V\infty}$ (mm)
Solid brick	$N_{Rk} / (1,4 \cdot \gamma_M)$	0,56	1,12	0,87	1,25
Hollow/perforated brick		0,81	1,62	1,20	1,80
Autoclaved aerated concrete		0,57	0,60	0,97	1,45

**Table C4:  $\beta$ -factors for job site tests according to ETAG 029 – Annex B**

Brick type	$\beta$ -factor
Solid and hollow/perforated brick EN 771-1 & EN 771-3	0,86
Autoclaved aerated concrete EN 771-4	0,76

**AT-HP masonry****Performances**Characteristic bending moment, displacements,  $\beta$ -factor**Annex C2**



**Table C5: Edge distances and spacings**

	$S_{cr}$ (mm)	$C_{cr}$ (mm)	$S_{min}$ (mm)	$C_{min}$ (mm)
Solid brick	20 x d	10 x d	50	50
Hollow/perforated brick	$l_{unit}$	$0.5 \times l_{unit}$	100	100
Autoclaved aerated concrete	20 x d	10 x d	50	50

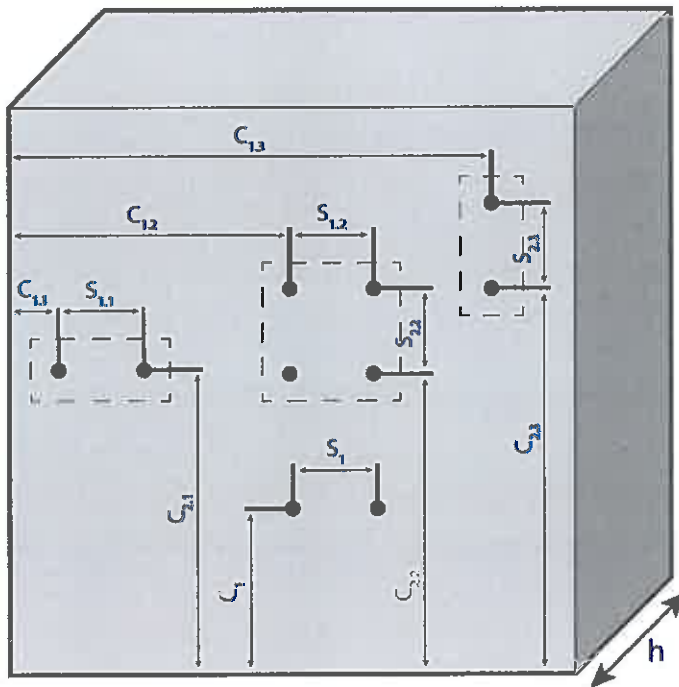

- d = nominal diameter of threaded rod
- $l_{unit}$  = maximum dimension of masonry unit
- h = thickness of masonry

<b>AT-HP masonry</b>	<b>Annex C3</b>
<b>Performances</b> Edge distances and spacing	

